

Apacer

The Most **Reliable**
Storage For Industries

UV110-UFD1



UV110-UFD1

Overview

Apacer's UV110-UFD1 utilizes 3D NAND for higher capacity up to 256GB and provides more power efficiency than 2D NAND, with the aim of replacing a conventional IDE hard disk drive. With exquisite size and robust metal housing, UV110-UFD1 prevents mechanical interference and enhances environment and ESD protection.



UV110-UFD1 is a new generation USB flash drive compatible with the latest USB specification – USB 3.2 Gen1 (SuperSpeed), with a maximum transfer rate of 5.0 Gbps. The connector is backward compatible with USB 2.0 and USB 1.1 interfaces. With compliance with USB 3.2 specification, this USB drive can deliver up to 270 MB/s outstanding performance.

Reliability wise, UV110-UFD1 is implemented with LDPC (Low Density Parity Check) ECC engine to extend SSD endurance and increase data reliability while reading raw data inside a flash chip. In addition, the drive comes with various implementations including powerful hardware ECC engine, Wear Leveling, flash block management, S.M.A.R.T., Page Mapping ,etc. This product is well suited for portable flash storage applications while operating at minimal power consumption.

Feature

- Adopts advanced LDPC ECC engine with 3D NAND flash memory to improve reliability
- Global Wear Leveling
- Flash bad-block management
- Page Mapping
- Power Failure Management
- S.M.A.R.T.
- Hyper Cache Technology
- SMART Read Refresh™

Specifications

Model	UV110-UFD1
Interface	USB 3.2 Gen1
Connector	USB Type A Plug
Form Factor	USB flash drive
NAND Flash Type	3D TLC
Capacity	128GB~256GB
External DRAM	No
Sustained Read Performance (MB/sec)	Up to 270
Sustained Write Performance (MB/sec)	Up to 185
ECC Engine	Low-Density Parity-Check (LDPC) Code
IOPS (4K Random Write)	900
Standard Operating Temperature (°C)	0 ~ + 70
Extended Operating Temperature (°C)	-40 ~ + 85 *Not supported on 16GB
Storage Temperature (°C)	-55 ~ + 100
Housing	Yes
H/W Write Protect	No
Shock	Operation: 50G/11ms (compliant with MIL-STD-202G) Non-operation: 1500G/0.5ms (compliant with MIL-STD-883K)
Vibration	Operation: 7.69 Grms, 20~2000 Hz/random (compliant with MIL-STD-810G) Non-operation: 4.02 Grms, 15~2000(Hz)/random (compliant with MIL-STD-810G)
Operating Voltage	5.0 V ± 5%
Power Consumption	Active mode: 220 mA; Idle mode: 85 mA
Dimension (L x W x H)	46.85 mm x 17.2 mm x 7.7 mm
MTBF (hours)	>3,000,000

Mechanical Specification

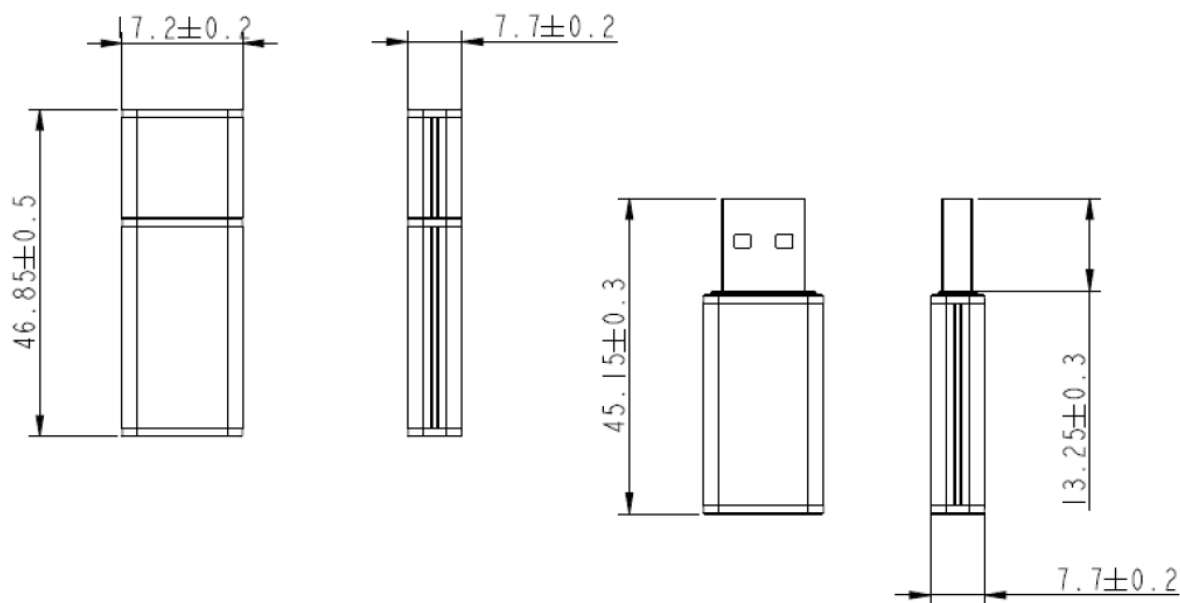

Unit: mm

For more information,
contact your Apacer representative

Global Presence

Taiwan (Headquarters)
Apacer Technology Inc.
Tel: +886-2-2267-8000
Fax: +886-2-2267-2261

Europe
Apacer Technology B.V.
Tel: +31-40-267-0000
Fax: +31-40-290-0686

U.S.A.
Apacer Memory America, Inc.
Tel: +1-408-518-8699
Fax: 1-510-249-9551

China
Apacer Electronic(Shanghai)
Co., Ltd.
Tel: +86-21-6228-9939

Japan
Apacer Technology Corp.
Tel: +81-3-5419-2668
Fax: +81-3-5419-0018

India
Apacer Technologies Pvt. Ltd.
Tel: +91-80-41529061~3
Fax: +91-80-41700215